



Delfield®

4472N SALAD TOP

Front-Breathing Self-Contained Compact Salad Top Refrigerators

Project _____

Item _____

Quantity _____

CSI Section 11400

4472N FRONT-BREATHING SELF-CONTAINED COMPACT SALAD TOP REFRIGERATORS

MODELS:

- | | | | |
|--|---|---|---|
| <input type="checkbox"/> 4472N-12 | Two section with doors
Twelve pan capacity | <input type="checkbox"/> D4472N-12 | Two section with drawers
Twelve pan capacity |
| <input type="checkbox"/> 4472N-18 | Two section with doors
Eighteen pan capacity | <input type="checkbox"/> D4472N-18 | Two section with drawers
Eighteen pan capacity |

STANDARD FEATURES

- Patented air screen ensures product stays cold without drying it out
- All 4400 Series units are 100% front breathing, which allows the unit to be pushed against a wall or built into a cabinet or an existing line up
- Durable, rugged stainless steel sides, top and front
- Features Delfield's exclusive ABS interior (on sides). ABS is extremely durable - it won't dent, chip or corrode and is backed by a limited lifetime warranty
- Delfield supplies 1/6 size pans and adapter bars for top opening
- Salad top refrigerators are standard with 10" wide, dishwasher safe polyethylene cutting board treated with antimicrobial agent
- "D" prefix models feature Delfield's new drawer system. Drawers are backed by a 10-year warranty on the track assembly
- Environmentally friendly R404A refrigerant
- High density foamed in place polyurethane keeps energy costs low
- Black recessed quick grip handle
- Standard on 2" casters for easy cleaning and installation
- 7' cord and plug supplied
- Cord spring relief - prevents cord rollover
- One epoxy coated wire shelf standard, installed per door section
- ACT solid state electronic control
- One year parts and 90 day labor standard warranty.

OPTIONS AND ACCESSORIES

- Flat lift off cover
 - 18" wide single tier overshelf
 - Stainless steel finish on back
 - Plastic laminate on front
 - Additional wire shelves
 - Door lock
 - Exterior thermometer
 - Interior lights
 - Glass door(s)
 - *220V/50 Hertz electrical system
- *Inclusion of this option will alter electrical specifications of the unit.



4472N-18



SPECIFICATIONS

Exterior top is one-piece 22-gauge stainless steel with integral 2.12" (5.1cm) square nosing at the front. Top has openings to accept 12 or 18 1/6-size 4" - 6" (10.2cm - 15.2cm) deep plastic pans. Adapter bars and 1/6 pans are supplied by Delfield. Temperature in top opening to maintain 33°F (1°C) to 41°F (5°C), with pans recessed 2.5" (6.4cm) at 86°F ambient room temperature, meeting NSF 7 requirements. One 72" x 10" x .5" (183cm x 25.4cm x 1.3cm) polyethylene cutting board treated with antimicrobial agent is mounted on the top at the front edge.

Exterior back and bottom are two-piece 24-gauge galvanized steel. Exterior ends are stainless steel.

Interior sides are thermoformed ABS plastic with shelf supports. Base is fully insulated with high-density foamed in place polyurethane.

Refrigeration system uses HFC-404A refrigerant. Compressor is 1/2 H.P., with condenser coil and condensate evaporator mounted on rear of the cabinet. Evaporator coils are located on the interior rear wall of the cabinet. Refrigerant flow is controlled by a capillary tube. Cabinet maintains an interior cabinet temperature of 36°F to 40°F (2°C to 4°C).

ACT control. ACT electronic, solid state control, mounted on the exterior rear of the cabinet, allows unit to maintain precise temperatures in heavy duty conditions.

Electrical connections are 115 volt, 60 Hertz, single phase. Unit has a 7' (2.1m) long electrical cord and NEMA 5-15P plug.

Castors: Equipment is mounted on 2" (5.08cm) diameter casters, with front three locking. Equipment clearance above the floor is 2.5" (6.35cm).

The following applies to three door models only
Doors have a 24-gauge stainless steel exterior, with thermoformed ABS plastic interior liner. Cabinet has one adjustable epoxy-coated wire shelf per door opening.

The following applies to six drawer models only
Drawer fronts have a 24-gauge stainless steel exterior, with thermoformed ABS plastic interior liner. Drawer frames and slides are 12-gauge stainless steel. Drawer slides are 11-gauge stainless steel with Delrin bearings. Each section has two drawers. Each top drawer holds one full size 12" x 20" (30.5cm x 50.8cm) pan and three 1/9 size pans 4" - 6" (10.6cm - 15.2cm) deep. Each bottom drawer holds one 12" x 20" (30.5cm x 50.8cm) pan 4" (10.6cm) and three 1/9 size deep pans. Pans supplied by others.



980 S. Isabella Road
Mt. Pleasant, MI 48858
www.delfield.com

Phone: 800-733-8948
Fax: 800-669-0619
Email: info@delfield.com

Approval _____

Date _____

4472N Front-Breathing Self-Contained Compact Salad Top Refrigerators

Pan Cutout Configurations

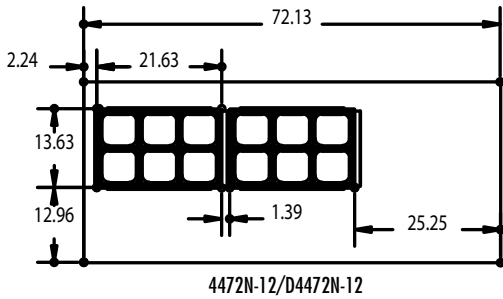

INSTALLATION NOTE:

Refrigeration system is designed so that air will flow under the unit, through the compressor area and out the front of the unit. Any restriction to this air flow path will void the warranties.

PLEASE NOTE:

Air flow through the louver on the back of the unit is not necessary for operation, however, any air which passes through the louver is beneficial.

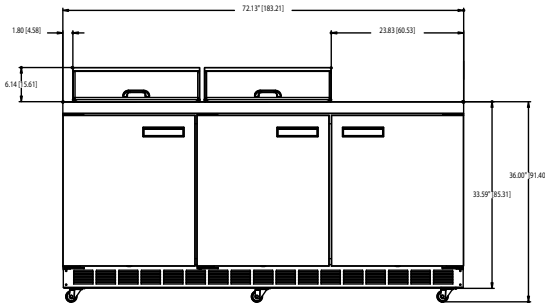

4472N-12 ELEVATION VIEW

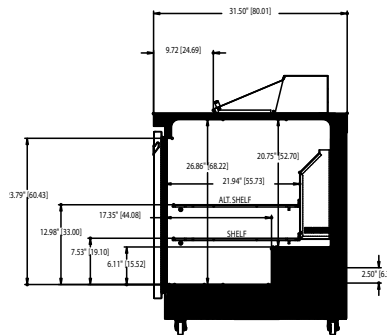

4472N-12 RIGHT SIDE VIEW

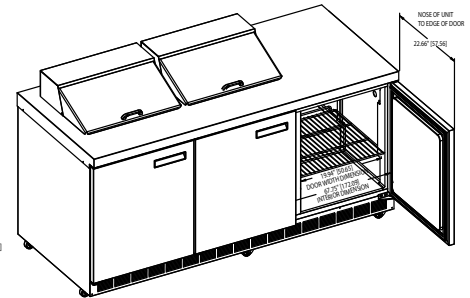

4472N-12 ISO VIEW

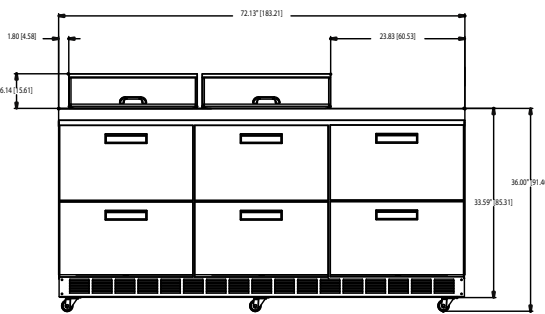

D4472N-12 ELEVATION VIEW

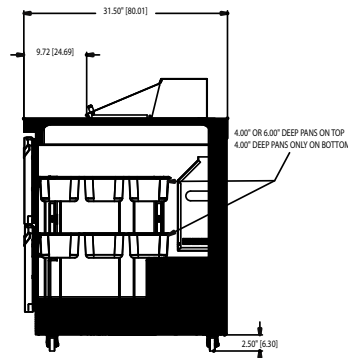

D4472N-12 RIGHT SIDE VIEW

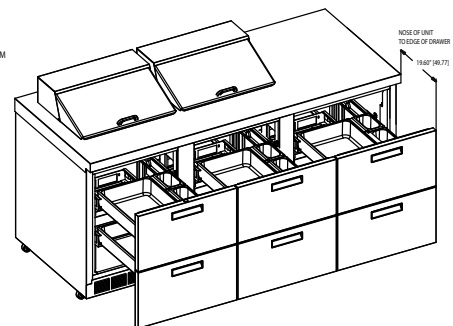

D4472N-12 ISO VIEW

4472N Front-Breathing Self-Contained Compact Salad Top Refrigerators

Pan Cutout Configurations

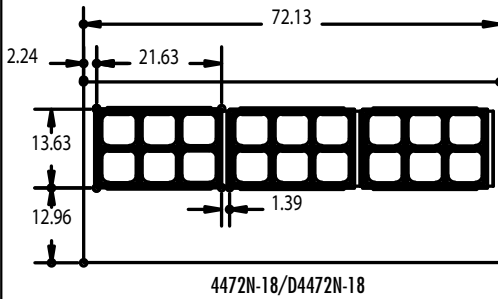

4472N-18/D4472N-18

INSTALLATION NOTE:

Refrigeration system is designed so that air will flow under the unit, through the compressor area and out the front of the unit. Any restriction to this air flow path will void the warranties.

PLEASE NOTE:

Air flow through the louver on the back of the unit is not necessary for operation, however, any air which passes through the louver is beneficial.

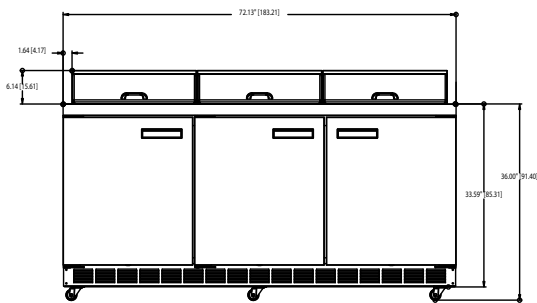

4472N-18 ELEVATION VIEW

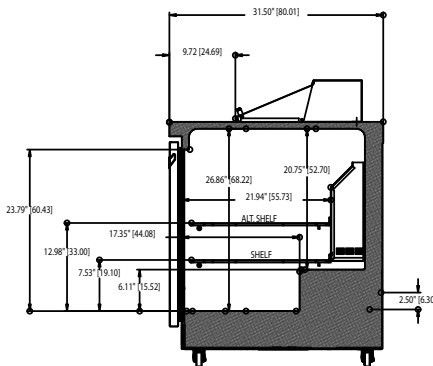

4472N-18 RIGHT SIDE VIEW

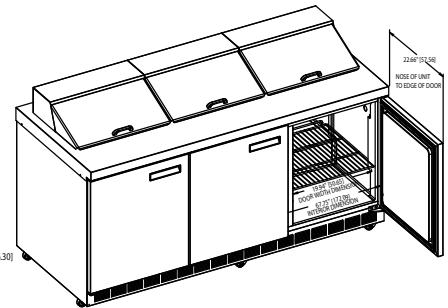

4472N-18 ISO VIEW

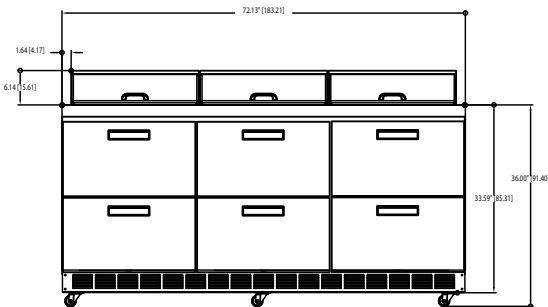

D4472N-18 ELEVATION VIEW

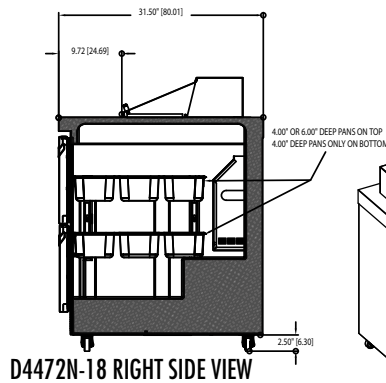

D4472N-18 RIGHT SIDE VIEW

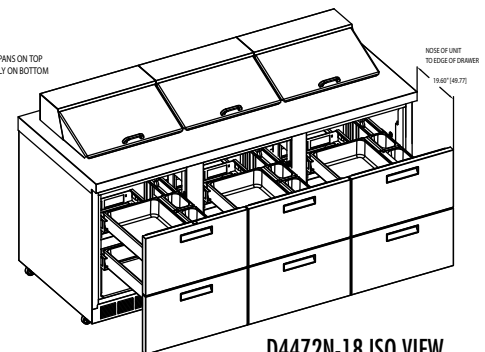

D4472N-18 ISO VIEW

Mechanical Data - Standard Unit

MODEL NUMBER	1/6 SIZE PAN CAPACITY	# OF SHELVES	SHELF AREA SQ.FT.	STORAGE CAP. CU.FT.	H.P.	VOLTS/HERTZ/PHASE	AMPS	NEMA PLUG	SHIP WEIGHT
4472N-12	12	2	8.42	18.7	1/2	115/60/1	12	5-15P	485LBS./220KG.
D4472N-12	12	NA	NA	4	1/2	115/60/1	12	5-15P	545LBS./247KG.
4472N-18	18	2	8.42	18.7	1/2	115/60/1	12	5-15P	485LBS./220KG.
D4472N-18	18	NA	NA	4	1/2	115/60/1	12	5-15P	545LBS./247KG.



980 S. Isabella Road
Mt. Pleasant, MI 48858
www.delfield.com

Phone: 800-733-8948
Fax: 800-669-0619
Email: info@delfield.com

Printed in the USA.
09/06
DS4472N-S